

Superior Solutions for Sheet Metal Fabricators

THIN TURRET TOOLING FOR STRIPPIT STYLE PUNCH PRESSES

- 1-1/4 STATION
- 3-1/2 STATION
- MATE XCEL™
- MATE MTG™
- SLUG FREE® DIES
- SPECIAL SHAPES



PN 2011

WORLDWIDE HEADQUARTERS:

1295 Lund Boulevard, Anoka, Minnesota 55303 USA

Tel 763.421.0230 Fax 763.421.0285

Toll Free: Tel 800.328.4492 Fax 800.541.0285

mate.com

MATE[®]
M
PRECISION
TOOLING

TRUSTED | QUALITY | SERVICE | SOLUTIONS

MATE PRECISION TOOLING

COMPANY OVERVIEW

Founded in 1962, Mate has grown into a world-class manufacturer of superior products and solutions for sheet metal fabricators. We manufacture tooling for every major CNC punch press, and offer a complete line of CO2 laser products.



Headquartered in Anoka, Minnesota, in a 300,000 sq. ft. state-of-the-art facility.

OUR MISSION: To be the world's leading supplier of precision tooling for CNC punch presses.

OUR PURPOSE: Helping sheet metal fabricators produce quality parts faster and more efficiently.

COMMITMENT TO QUALITY



Mate's dedication to quality is not just demonstrated in the products and services we provide, it is a part of every aspect of our business. This commitment was formally recognized when Mate was honored with the 2005 Minnesota Quality Award Achievement level. We integrate the Baldrige National Quality Program's criteria into the way we operate and continually measure our progress in improving our products, processes, and service.

CUSTOMER SATISFACTION GUARANTEED

Customer service is a critical component of Mate's business. Mate's Sales Engineers are experts in their field working on site with customers to solve fabricating issues. This commitment to customer satisfaction is extended around the world with Mate tooling experts available in every industrialized country. Customer education is available for every product Mate offers and is available 24/7 at mate.com. My.mate.com, a free web-based portal, allows registered users access to previously ordered drawings of special shapes and assemblies. Mate offers an extensive standard product line that can be delivered with same day or next day service and all our products come with a 100% satisfaction guarantee.

PRODUCTS AND SOLUTIONS THAT WORK

Mate's product engineering team currently holds several national and international patents and continues to develop products that push the boundaries of manufacturing technology. Our state-of-the-art technology center is an integral part of this process. It allows us to develop and test new tooling concepts and designs, and focus on proving the viability of value-added products while reducing the time needed to bring these products to market. The technology center also allows us to replicate the end user's environment and needs in every way. We work closely with the world's leading sheet metal fabricators and punch press manufacturers conducting research and evaluating new products. These partnerships bring to Mate a combined effort to continually offer customers superior products with proven solutions.

SPANNING THE GLOBE

Mate has over 80 dealers providing products and services in every industrialized country, and Mate's European operations are headquartered in Oberursel, Germany. Our dealers are thoroughly trained to assist with all tooling needs from simple hole punching to complex special applications. Mate recognized the need for an international specialist in the punch press tooling field and has been serving the international market since 1967. Our commitment to serving manufacturers around the world was formally recognized when Mate was presented with the President's "E" Certificate for Exports by the Secretary of Commerce in 1996. Since the year 2000, approximately 40% percent of Mate's revenue has come from outside the United States. We are committed to improving manufacturing technology around the world, by helping established and emerging manufacturers produce quality parts faster and more efficiently.



[Dimensions in Inches(mm)]

TABLE OF CONTENTS

1-1/4" Tooling	4-6	Special Applications	21-31
1/2" Snap-Apart Tooling for 1-1/4" Station	4	Cluster	22
5/8" Drop-In Tooling for 1-1/4" Station	5	Card Guide	22
1-1/4" Full Body Tooling for 1-1/4" Station	6	Countersink	23
		Emboss - Beaded	23
		Cold Forged	24
Accessories — 1-1/4" and 3-1/2"	7	Emboss - Formed	24
1-1/4" and 3-1/2" Station Alignment Tools		Extrusion-Tapping	25
1-1/4" and 3-1/2" Station Punch and Die Adapters		Hinge	25
		Knockout	26
		Louver	26
Mate Xcel™ Tooling	8-15	Lance and Form	27
1-1/4" Station	8-9	Stamping-Alpha Numeric	27
2" Station	10-11	Stamping-V-Line Inscription	28
3-1/2" Station	12-13	Threadform	28
Fully Guided Tooling System for 3-1/2" Station	14	Mate Rollerball®	29
Tooling System Cluster Assemblies	15	Mate Sheetmarker®	29
		Mate SnapLock™	30
		Mate HexLock™	30
		Mate EasySnap™	31
		Mate 19" Racking Cluster	31
Multi Tool Systems	16-17		
Xcel™ 3 and 8-Station Multi Tools	16	Mate Special Shapes	32-33
MTG™ Tooling	17		
Accessories — Xcel™	17-18	Technical Data	34-37
Xcel™ 3-1/2" Punch Guide Accessories	17	Total Die Clearance and Hole Quality	34
Maintenance Fixture	18	Calculating Punching Force	35
		Angle Setting Details	36
Tooling Technical Data and Tooling Enhancements	19-21	Add-Ons for Rounds and Shapes	36
Strippit Style Tooling Features and Benefits	19	Dimensional and Punch Grind Life Data	37
Mate DuraSteel™ High Performance Tool Steel	19		
Maxima® Coating	20		
Mate Slug Free® Dies	20		



[Dimensions in Inches(mm)]

1/2" SNAP-APART TOOLING FOR 1-1/4" STATION

Upper Assembly

Round punch assembly
Shaped punch assembly

(Includes punch head, spring, spring retainer, guide, punch, and stripper)

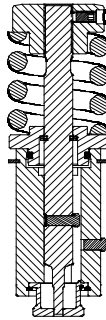

Punch

Round* **PCSA0A**
Shape* **PCSA_A**
Ring**
(2 req'd) **SRI00002**
Maxima® Coating

DuraSteel™



Hardware

Punch Head **MATE00393**
Spring **MATE00007**
Spring Retainer (with O-ring)
MATE00011
Support Ring **SRI00003**
Guide—Round **MATE00014**
Guide—Shape **MATE00016**
Stripper Retaining Ring
SRI00004

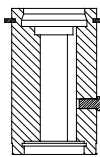
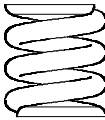
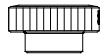

Stripper

Round* **SCSA0A**
Shape* **SCSA_A**



Slug Free® Die

Round **DASB00**
Shape **DASB_0**
Shim Pack **MSAB**

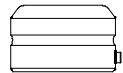

* Can be used with existing 1/2" drop-in style holders.
** Snap ring supplied with each punch. Must be removed for use in Strippit style guide assembly.

Urethane Slug Ejector—3.00mm	URE40002 (12 minimum)
Urethane Slug Ejector—6.00mm	URE40010 (12 minimum)
2.5mm Hex Wrench	MIS98896
Medium India Oil Stone	STO29807
Snap Ring Pliers	MIS61129
Punch head set screw (cone point)	SSS00005
Punch head set screw kit (flat point)	MATE00698



[Dimensions in Inches(mm)]

5/8" DROP-IN TOOLING FOR 1-1/4" STATION

5

1-1/4" STATION

Upper Assembly

Round punch assembly

Shaped punch assembly

(Includes punch head, guide and canister assembly, punch, and stripper)

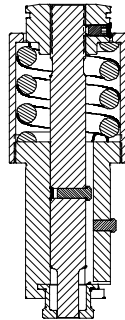

Punch

Round **PDSX0A**

Shape **PDSX_A**

Maxima® Coating

DuraSteel™



Stripper

Round **SDSX0A**

Shape **SDSX_A**

Round** **SESX0A**

Shape** **SESX_A**



Hardware

Punch Head **MATE00386**

Canister and Guide Assembly

MATE00391

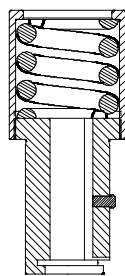

Slug Free® Die

Round **DASB00**

Shape **DASB_0**

Shim Pack **MSAB**

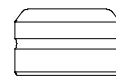

Urethane Slug Ejector—3.00mm	URE40002 (12 minimum)
Urethane Slug Ejector—6.00mm	URE40010 (12 minimum)
2.5mm Hex Wrench	MIS98896
Medium India Oil Stone	STO29807
Punch head set screw (cone point)	SSS00005
Punch head set screw kit (flat point)	MATE00698

STANDARD SHAPES:

rectangle square quad "D" round hexagon octagon oval single "D" double "D" triangle diamond



[Dimensions in Inches(mm)]



1-1/4" FULL BODY TOOLING FOR 1-1/4" STATION

Upper Assembly

Round punch assembly
Shaped punch assembly

(Includes punch head, spring, spring retainer, punch, and stripper)

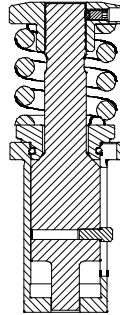

Punch

DuraSteel™

Round **PBSB0A**
Shape **PBSB_A**
Maxima® Coating

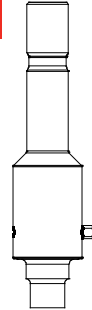

Stripper

Round **SBSB0A**
Shape **SBSB_A**

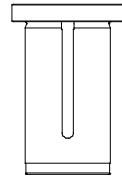

Hardware

Punch Head **MATE00388**
Spring **MATE00007**
Spring Retainer
(with O-Ring) **MATE00003**
Punch Shim **MATE00333**

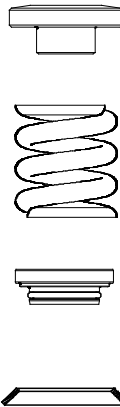

Slug Free® Die

Round **DASB00**
Shape **DASB_0**
Shim Pack **MSAB**

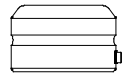

Urethane Slug Ejector—3.00mm	URE40002 (12 minimum)
Urethane Slug Ejector—6.00mm	URE40010 (12 minimum)
2.5mm Hex Wrench	MIS98896
Medium India Oil Stone	STO29807
Punch head set screw (cone point)	SSS00005
Punch head set screw kit (flat point)	MATE00698



[Dimensions in Inches(mm)]

1-1/4" AND 3-1/2" STATION ALIGNMENT TOOLS

Mate manufactures a comprehensive range of alignment tools to enable you to restore the alignment of each station with the same or better precision as the initial machine installation. Superior piece part quality, extended machine life, and longer tool life is achieved when the upper and lower turrets of a punch press are precisely aligned.

ALIGNMENT PACKAGE	MATE00736
COMPRISES:	
A 1-1/4" Station Upper Alignment Tool	VSALTB
B 1-1/4" Station Lower Alignment Tool	MAALTB
C 3-1/2" Station Upper Alignment Tool	VSALTD
D 3-1/2" Station Lower Alignment Tool	MSALTD
E Handle	VNALT
F Alignment Bar	NLUBAR
G Adjustment Rod	NALROD

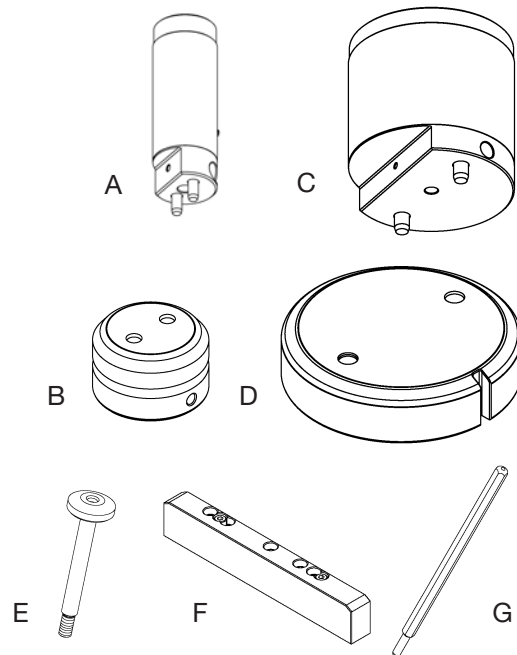

1-1/4" AND 3-1/2" STATION PUNCH AND DIE ADAPTERS

Mate manufactures a comprehensive range of adapters to allow 1-1/4" tooling to be used in 3-1/2" stations in a variety of Strippit Style Tooled punch presses.

Machine Style	Station Configuration	Piercing or Forming	Upper Adapter Assembly	Lower Adapter Assembly
Strippit Style*	Standard	Both	MATE00740	MATE00742
Finn-Power**	Upforming	Piercing	MATE00740	MATE00744
		Forming	MATE00740	MATE00742
Finn-Power**	Upforming Auto-Index	Piercing	MATE00740	MATE00746
		Forming	N/A***	N/A***

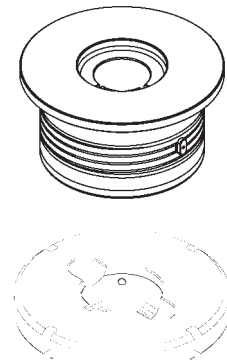

* includes all punch presses that are configured to accept Strippit Style Tooling, including Finn-Power punch presses that do not have the upforming forming capability in the 3-1/2" station. Not compatible with Strippit "R" series machines.

** Finn-Power machines with upforming capability in the 3-1/2" D stations use different lower adapters as shown in the table above.

*** The use of a 3-1/2" D station forming assembly is recommended when forming in a Finn-Power punch press with upforming capability in the Auto-Index station.

[Dimensions in Inches(mm)]



MATE XCEL™ TOOLING SYSTEM FOR 1-1/4" STATION

Introducing the Mate Xcel™ Tooling System for 1-1/4" Thin Turret Stations. Mate Xcel is a high performance tooling system with features designed to reduce set-up time, improve piece part quality and maximize productivity.

Features include:

MATE XCEL™ CANISTER ASSEMBLY

- Quick punch length adjustment without disassembly for rapid tool change and maximum productivity.
- Push button mechanism allows punch length adjustment in 0.008(0.20) increments for quick and precise tool set-up.
- Superior engagement between canister and guide to prevent length adjustment during punching cycle.
- Self-contained, pre-loaded spring pack for consistent stripping pressure and reliable operation.
- Maximum punch-head surface area for positive contact with machine ram for reliable operation.
- Compatible with existing tooling inventory for added economy and maximum flexibility.

PUNCH

- DuraSteel™ with superior hardness and toughness for extended interval between regrinds.
- Hardened double-D key for precise orientation of punches for improved piece part quality.
- 1/4 degree back taper and near polished punch flanks to reduce friction, eliminate galling, and maximize punch life.
- Maxima® coating available for extreme applications to reduce galling and improve stripping.

STRIPPER GUIDE

- Hardened and ground with superior concentricity for reduced friction and longer tool life.
- Smooth rounded edges to eliminate sheet marking and improve piece part quality.
- Compatible with existing conventional thin turret tooling inventory for maximum flexibility.

SLUG FREE® DIE

- Slug Free die geometry eliminates slug pulling to improve piece part quality and increase tool life.
- Highly wear-resistant tool steel provides optimum balance between hardness and toughness, for extended service life.



- **Quality**
- **Durability**
- **Reliability**
- **Performance**
- **Compatibility**



[Dimensions in Inches(mm)]

MATE XCEL™ TOOLING SYSTEM FOR 1-1/4" STATION

9

MATE XCEL™ TOOLING SYSTEM

Upper Assembly

Round
Shape

(Includes canister, punch and stripper)

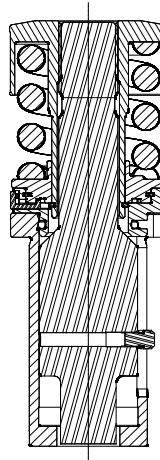

Punch

Round **PBSB0A**
Shape **PBSB_A**
Maxima® Coating

DuraSteel™

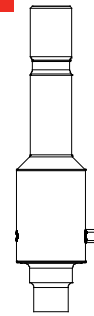

Stripper

Round **SBSB0A**
Shape **SBSB_A**

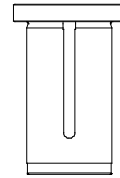

Hardware

1-1/4" Canister
MATE00690

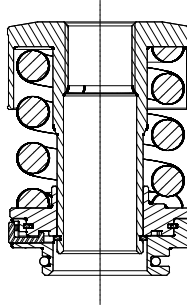

Slug Free® Die

Round **DASB00**
Shape **DASB_0**
Shim Pack **MSAB**

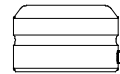

Urethane Slug Ejector—3.00mm	URE40002 (12 minimum)
Urethane Slug Ejector—6.00mm	URE40010 (12 minimum)
Medium India Oil Stone	STO29807

STANDARD SHAPES:

rectangle square quad "D" round hexagon octagon oval single "D" double "D" triangle diamond



[Dimensions in Inches(mm)]



MATE XCEL™ 2" GUIDE ASSEMBLY AND STRIPPIT STYLE TOOLING

The Mate Xcel™ 2" Guide Assembly and Strippit Style Tooling for 2" thin turret stations is Mate's high performance tooling designed to improve piece part quality and maximize productivity. Punches, dies, and strippers are fully compatible with existing 2" thin turret Strippit Style holders.

MATE XCEL™ 2" GUIDE ASSEMBLY

- Quick length adjustment; push button on guide flange allows punch length adjustment in 0.005(0.13) increments without disassembly or additional tools
- Quick change stripper mechanism; lock button allows tool-less stripper removal and installation
- Hardened guide body reduces friction within the turret and guide key and keyways assure precise punch alignment for higher piece part quality
- Internal and external grooves for enhanced lubrication

PUNCH

- DuraSteel™ with superior hardness and toughness for extended interval between regrinds
- Hardened pin for precise orientation of punches for improved piece part quality
- 1/4 degree back taper and near polished punch flanks to reduce friction, eliminate galling, and maximize punch life
- Maxima™ coating available for extreme applications

STRIPPER

- Smooth rounded edges to eliminate sheet marking and improve piece part quality
- Compatible with existing conventional thin turret tooling inventory for maximum flexibility*

SLUG FREE® DIE

- SLUG FREE die geometry eliminates slug pulling to improve piece part quality and increase tool life
- Highly wear-resistant tool steel provides optimum balance between hardness and toughness, for extended service life



[Dimensions in Inches(mm)]

MATE XCEL™ 2" GUIDE ASSEMBLY AND STRIPPIT STYLE TOOLING

11

MATE XCEL™ TOOLING SYSTEM

Holder

Mate Xcel™ 2" Guide Assembly

MATE01715

Punch

Round **PLSC0A**

Shape **PLSC_A**

Stripper

Round **SLSC0A**

Shape **SLSC_A**

SLUG FREE® Die

Round **DCSC00**

Shape **DCSC_0**

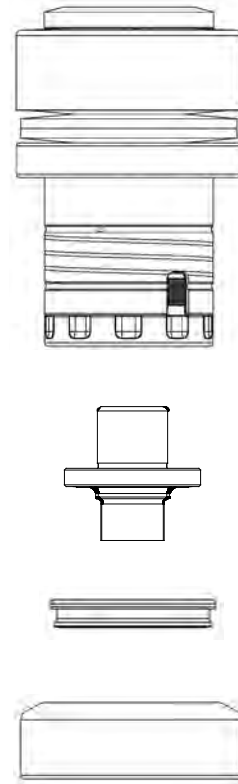

ADD-ONS FOR ROUNDS AND SHAPES:

Urethane Slug Ejector—3.00mm	URE40002 (12 minimum)
Urethane Slug Ejector—6.00mm	URE40010 (12 minimum)
Maxima™ Coating	

Narrow Width

Round point diameter is less than 0.061(1.55) - add 25% to punch, stripper and die
 Round point diameter is less than 0.092(2.35) - add 10% to punch, stripper and die
 Shape point width is less than 0.079(2.00) - add 25% to punch, stripper and die

Non-Standard Angle Setting

Punches - add 25% to price
 Dies - add 25% to price

STANDARD SHAPES:

rectangle square quad "D" round hexagon octagon oval single "D" double "D" triangle diamond



[Dimensions in Inches(mm)]



MATE XCEL™ TOOLING SYSTEM FOR 3-1/2" STATION

The Mate Xcel™ Tooling System for 3-1/2" stations deliver higher quality piece parts, with greater interval between regrinds. The two Xcel™ Punch Guide Assemblies combine innovative product design, superior material selection and high quality manufacturing processes to deliver unmatched punching performance.

Xcel Guide Assembly for Inch Shank Punches—fully compatible with existing inventory.

Xcel Guide Assembly for Slitting Punch Insert—accepts Mate Premium M4PM™ High Speed Steel inserts.

Both Mate Xcel punch guide assemblies can use conventional strippers (see page 7) for full compatibility with existing inventory, or new fully guided strippers (see page 11) to guide the tip of the punch for superior punching performance.

- **Quick Length Adjustment** —The push button on the flange of the guide allows the punch length to be adjusted in increments of 0.005(0.13) without disassembly or additional tools.
- **Stripper**—Toughened tool steel to maximize service life. Smooth rounded edges to eliminate sheet marking and improve piece part quality.
- **Fully Guided Stripper**—The punch guide assembly holds the stripper rigidly, while the stripper guides the tip of the punch, for truly exceptional fully guided punching performance. Punch to stripper clearance = 0.0017(0.04). Stripper to guide clearance = 0.0006(0.02).
- **Quick Change Stripper Mechanism**—The stripper lock button on the side of the guide releases the simple, replaceable stripper locking ring which allows the standard or fully guided stripper to be installed and removed without additional tools.
- **Hardened Guide Body**—Resists dents and scratches to reduce friction within the turret and extend machine and tool life.
- **Hardened Guide Key**— One-piece key and hardened keyways assure precise alignment of the punch within the guide and the guide within the turret for higher piece part quality and longer tool life.
- **Tool Lubrication**—The guide body includes internal and external grooves to allow efficient delivery of tool lubrication to all critical surfaces.
- **Quick Change Angle Settings**—The upper push button provides quick release of the guide body to allow multiple angle settings to be achieved without additional tooling.



Mate Xcel™ fully guided punch guide assembly, with inch shank punch.



Mate Xcel™ fully guided punch guide assembly, with slitting punch insert.



[Dimensions in Inches(mm)]

MATE XCEL™ TOOLING SYSTEM FOR 3-1/2" STATION

13

MATE XCEL™ TOOLING SYSTEM

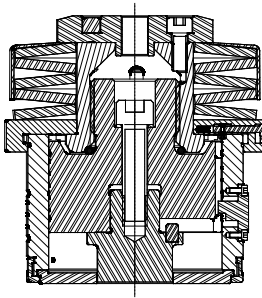

Upper Round Punch Assembly

DIAGONAL	SHAPE	PRICE
1.251 to 1.500	Round	
	Shape	
1.501 to 2.500	Round	
	Shape	
2.501 to 3.500	Round	
	Shape	

(Includes punch,stripper and hardware)

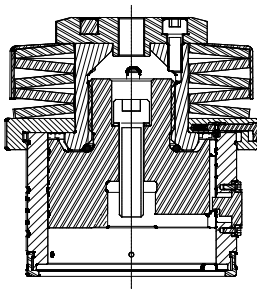

Hardware

3-1/2" Guide **MATE00869**

Inch Shank Punch

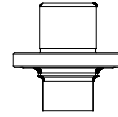

DIAGONAL	SHAPE	PART NUMBER	PRICE
1.251 to 1.500	Round	PLSD0A	
	Shape	PLSD_A	
1.501 to 2.500	Round	PLSF0A	
	Shape	PLSF_A	
2.501 to 3.500	Round	PLSH0A	
	Shape	PLSH_A	

Maxima® Coating

Stripper

Round	SLSD0A
Shape	SLSD_A



Slug Free® Die

Round	DCSD00
Shape	DCSD_0
Shim Pack	MSAD



Urethane Slug Ejector—3.00mm	URE40002 (12 minimum)
Urethane Slug Ejector—6.00mm	URE40010 (12 minimum)
2.5mm Hex Wrench	MIS98896
Medium India Oil Stone	STO29807

Note: This product is manufactured under license from Wilson Tool (Pat. 5,127,293)

STANDARD SHAPES:

rectangle square quad "D" round hexagon octagon oval single "D" double "D" triangle diamond



[Dimensions in Inches(mm)]



MATE XCEL™ FULLY GUIDED TOOLING SYSTEM FOR 3-1/2" STATION

Xcel™ Guide Assembly for Inch Shank Punches

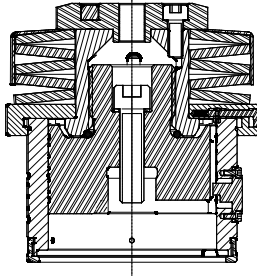

- External length adjustment
- Six angle settings
- Quick change stripper

MATE00869

Xcel™ Guide Assembly for Slitting Punch Inserts

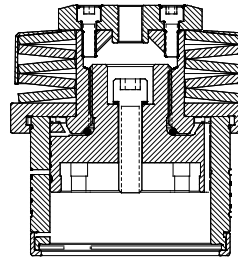

- External length adjustment
- Four angle settings
- Quick change stripper

MATE00868

Inch Shank Punch

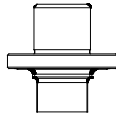

Diagonal	Shape	Part Number	Price
1.251 to 1.500	Round	PLSD0A	
	Shape	PLSD_A	
1.501 to 2.500	Round	PLSF0A	
	Shape	PLSF_A	
2.501 to 3.500	Round	PLSH0A	
	Shape	PLSH_A	

Maxima® Coating

Slitting Punch Insert

Front view

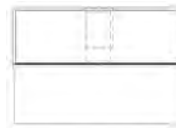

Side view



Shape **PJSQ_A**

Maxima® Coating

Mate M4PM™ High Speed Steel is a very homogeneous, high quality tool steel, with superior wear resistance and increased toughness. Users prove it outperforms conventional tool steels.

The Mate Xcel™ Fully Guided tooling system is the only system to deliver true fully guided punching performance.

- The clearance between the punch and the stripper is 0.0017(0.04).
- The clearance between the stripper and the guide is 0.0006(0.02).

The guide holds the stripper rigidly, while the stripper guides the tip of the punch.

Fully Guided Stripper



Round	SJSD0A
Shape	SJSD_A

Slug Free® Die

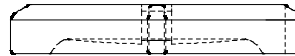

Round	DCSD00
Shape	DCSD_0
Shim Pack	MSAD

Mate Slug Free® dies supplied as standard.

- eliminate slug pulling
- reduce tool breakage
- improve tool life
- increase piece part quality

Note: This product is manufactured under license from Wilson Tool (Pat. 5,127,293)



[Dimensions in Inches(mm)]

MATE XCEL™ TOOLING SYSTEM CLUSTER ASSEMBLIES

Mate Xcel™ Cluster Assemblies are designed to take advantage of the many features offered by the Mate Xcel 3-1/2" Punch Guide Assembly. They combine convenience of replaceable inserts, the precision of the integrated punch driver, and the performance of the Mate Xcel 3-1/2" Punch Guide Assembly.

Mate Xcel Cluster Assemblies combine many components including:

- **Integrated Punch Driver**—designed with the same precision as the original punch driver, for precise interchangeability.
- **Punch Inserts**—High Speed Steel punch inserts maximize the interval between regrinds. The near polished punch flanks with 1/4 degree back taper reduce friction and extend punch life. Maxima® coating available for extreme punch applications.
- **Retainer Plate**—produced using advance Electro Discharge Machining (EDM) technology to guarantee the angularity and concentricity that is essential when using a high performance cluster assembly.
- **Stripper Plate**—Toughened tool steel to maximize service life. Smooth rounded edges to eliminate sheet marking and improve piece part quality.
- **Slug Free® Die**—eliminates slug pulling to improve piece part quality and increase tool life. Highly wear-resistant tool steel provides optimum balance between hardness and toughness, for extended service life.
- **Mate Xcel™ Guide Assembly**—Complete interchangeability between cluster assemblies and conventional Strippit Style tooling applications. Quick length adjustment and quick change stripper mechanism for rapid tool changes.

Mate Xcel guide assembly required for compatibility with Mate cluster assembly. Allows user to use inch shank punches when not using the cluster assembly.



Cluster assembly is designed to take full advantage of the many features offered by the Xcel 3-1/2" Guide assembly.



Use the quick release features on the guide assembly, to disassemble the cluster. Unscrew the integral punch driver assembly.



Re-install the original punch driver supplied with the guide, to convert the guide for use with conventional Strippit style tooling.



The Mate Xcel 3-1/2" is now ready for use with your conventional Strippit style tooling.

[Dimensions in Inches(mm)]



MATE XCEL™ MULTI TOOL SYSTEM FOR STRIPPIT STYLE THIN TURRET PRESSES

What is a Multi Tool? - It is a tool which expands the capacity of any one station of a CNC punch press by allowing more than one punch and die set to be placed in a machine station.

Mate is a world-leading supplier of Multi Tool systems with a comprehensive range of world class Multi Tool products. Including Xcel™ 3 station and 8 station systems for Strippit presses. These products are designed and engineered as an integral part of the high performance machines in which they operate.

Xcel™ 3 Station (1.250") Multi Tool Assembly

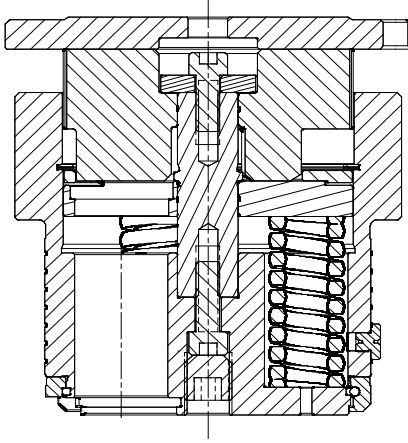

Upper Assembly for Global Machines—
MATE00109

Upper Assembly for Non-Global Machines—
MATE00640

Lower Assembly—
MSMS104937

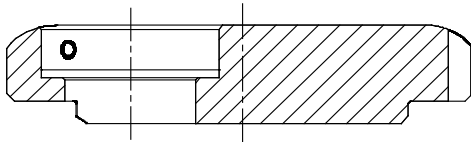

Xcel™ 8 Station (0.500") Multi Tool Assembly

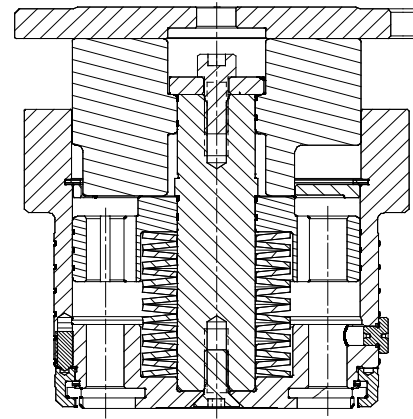

Upper Assembly for Global Machines—
MATE00096

Upper Assembly for Non-Global Machines—
MATE00641

Lower Assembly—
MSM2204937

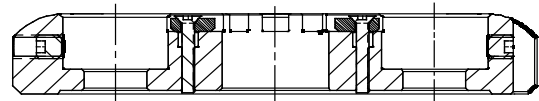

User benefits include:

- Durable construction, designed for continuous operation in Flexible Manufacturing Systems (FMS) commonly featured in Strippit installations.
- Maximum station range capacity options available, for increased productivity.
- 3 Station 1.250(31.75) - Add extra capacity to your turret!
- 8 Station 0.500(12.70) - Useful for intricate detail holes.
- Upper punch cassette is removable for quick and easy tool changes.
- Internal lubrication features of upper punch cassette support high speed operation.
- Die cassette includes slide-in design and central die retention mechanism to reduce tool change time and increase productivity.
- Full OEM compatibility with both Global and Non-Global style punch presses.



[Dimensions in Inches(mm)]

MTG™ 3 STATION (1.250") MULTI TOOL MTG™ 8 STATION (0.500") MULTI TOOL

MTG™ 3 Station (1.250)

Punch - Durasteel™

Round **PMSQ0A**
Shape **PMSQ_A**
Maxima® Coating

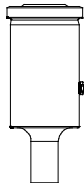

Stripper

Round **SMSQ0A**
Shape **SMSQ_A**



Die

Round **DESQ00**
Shape **DESQ_0**

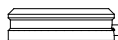

MTG™ 8 Station (0.500)

Punch - Durasteel™

Round **PMSR0A**
Shape **PMSR_A**
Maxima® Coating



Stripper

Round **SMSR0A**
Shape **SMSR_A**



Die

Round **DESR00**
Shape **DESR_0**



MATE XCEL™ 3-1/2" STATION PUNCH GUIDE ACCESSORIES

Xcel™ Replacement Locking Ring

MATE00402

Fully compatible with all Xcel punch guide assemblies.

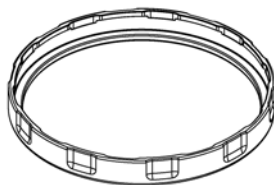

Xcel™ Punch Guide Field Service Kit

MATE00894

Replacement guide body kit for Xcel Slitting Punch Insert Guide Assembly (MATE00868), and Xcel Inch Shank Punch Guide Assembly (MATE00869). Kit includes guide body, guide key, stripper lock button, and detailed installation instructions.

Also allows Xcel guides (MATE00340) manufactured before July 2007, to be converted to accept fully guided strippers.

Fully compatible with all Xcel punch guide assemblies.

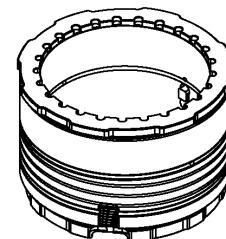

Xcel™ Inch Shank Punch Driver Kit

MATE00896

Convert existing Xcel Slitting Punch Insert Guide Assembly (MATE00868), to accept inch shank punches.

Fully compatible with all Xcel punch guide assemblies.

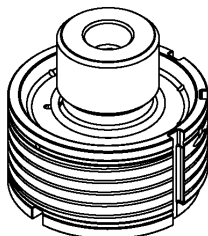

Xcel™ Slitting Insert Punch Driver Kit

MATE00807

Convert existing Xcel Inch Shank Punch Guide Assembly (MATE00869), to accept Slitting Punch Inserts.

Fully compatible with all Xcel punch guide assemblies.

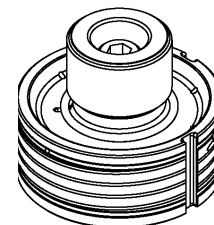

[Dimensions in Inches(mm)]



MATE XCEL™ MAINTENANCE FIXTURE FOR THIN TURRET TOOLING

The Mate Xcel™ maintenance fixture is a multi-function fixture designed to make installation and maintenance of thin turret tooling quick, simple, and reliable. The fixture includes a universal clamp and three Quick-Set locations.

- The universal clamp allows 1/2" Snap-Apart, 5/8" Drop-In, and 1-1/4" Full Body punches to be held securely to allow the installation and adjustment of punch heads, springs, and spring retainers.
- Quick-Set positions 1 and 2 enable tooling with an orientation key to be installed and adjusted without using the universal clamp for added speed. (see drawing below)
- Quick-Set position 3 holds the Mate Xcel™ 3-1/2" guide securely in place to allow the punch draw bolt to be tightened to the correct torque setting for reliable operation. (see drawing below)

The Mate Xcel maintenance fixture can be mounted to a bench, or clamped in a vice, for maximum convenience.



MATE00700

Installation and Use Instructions.

The Mate Xcel™ Maintenance Fixture is simple to install.

- **Bench Mounted**—Use the 3/8-16 x 4" (100mm) bolts supplied to attach the clamp bar, through the bench, to the body of the fixture. Ideal for more permanent installations.
- **Vice Mounted**—Use the 3/8-16 x 2" (50mm) bolts supplied to attach the clamp bar to the body. Then mount the fixture into a vice. Ideal for temporary installations.

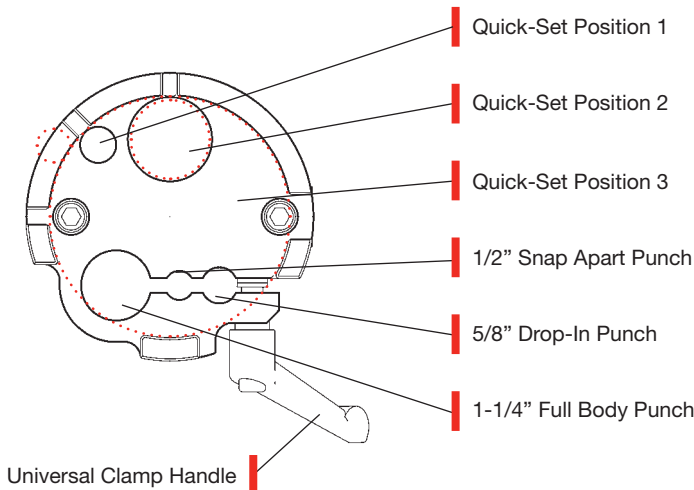

Tooling Description	Feature
1/2" Snap-Apart Punch	Clamp
1/2" Snap-Apart Shaped Punch	Quick-Set 1
5/8" Drop-In Punch	Clamp
5/8" Drop-In Shaped Punch	Quick-Set 1
1-1/4" Full Body Punch	Clamp
1/2" Snap-Apart Assembly	Quick-Set 2
5/8" Drop-In Assembly	Quick-Set 2
1-1/4" Full Body Assembly	Quick-Set 2
3-1/2" Xcel Guide Assembly	Quick-Set 3



[Dimensions in Inches(mm)]

STRIPPIT STYLE TOOLING FEATURE AND BENEFITS

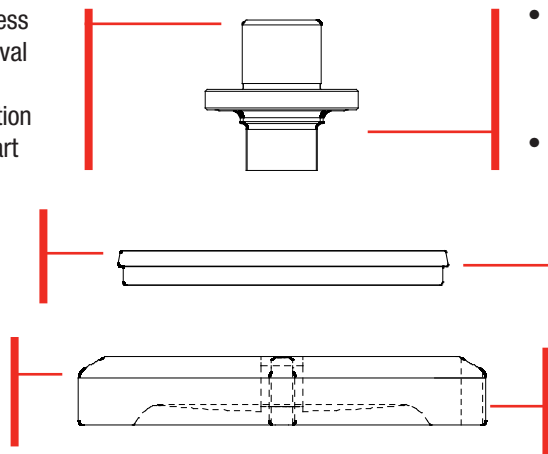
- DuraSteel™ with superior hardness and toughness for extended interval between regrinds.
 - Hardened key for precise orientation of punches for improved piece part quality.
 - Smooth rounded edges to eliminate sheet marking and improve piece part quality.
 - Slug Free® die geometry eliminates slug pulling to improve piece part quality and increase tool life.
- 
- 1/4 degree back taper and near polished punch flanks to reduce friction, eliminate galling, and maximize punch life.
 - Maxima® coating available for extreme applications.
 - Ground for superior angularity and concentricity.
 - Highly wear-resistant tool steel provides optimum balance between hardness and toughness, for extended life.

MATE DURASTEEL™ HIGH PERFORMANCE TOOL STEEL

Mate DuraSteel™ is an air hardened tool steel designed specifically for use in high performance tooling systems.

A combination of the chemical composition of Mate DuraSteel and the closely controlled manufacturing process results in an upgrade to conventional High Chrome D2 tool steel. It offers better wear resistance, greater toughness, better compressive strength, and higher attainable hardness.

Mate DuraSteel is a high quality tool steel which has many advantages when compared to alternative tool steels commonly available. These advantages include:

Superior Wear Resistance—Mate DuraSteel offers superior resistance to adhesive- and abrasive-wear to maximize the interval between regrinds.

- Increased Vanadium carbides—harder wearing than chromium carbides for greater resistance to abrasive-wear.
- Increased Tungsten carbides—harder wearing and offer better red hardness; increased resistance to high temperatures may anneal or damage the material.
- Higher hardness—increased alloy content results in higher effective hardness for better wear resistance.

Increased Toughness—the chemical composition and heat treatment processes used with Mate DuraSteel make it tougher than conventional tool steels in impact strength tests.

The inclusion of tungsten and vanadium allows the carbon content to be reduced, which increases the toughness.

Better Value—Customer trials have shown that tools manufactured in Mate

DuraSteel last 100% longer between regrinds than tools manufactured using conventional tool steels. By increasing the interval between regrinds, the tooling lasts longer and punches many more holes before needing to be replaced.

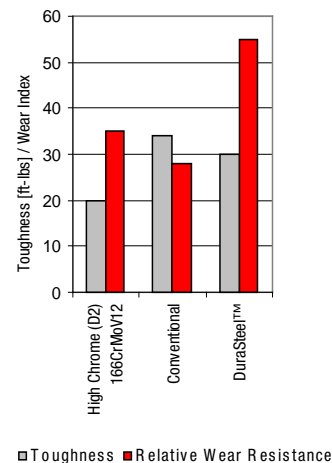

DuraSteel™ Chemical Composition	
Carbon	1.10%
Chromium	7.50%
Vanadium	2.40%
Tungsten	1.15%
Molybdenum	1.60%

- Toughness: Charpy C-Notch impact strength test.
- Relative Wear Resistance: 10x Cross cylinder adhesive wear test.
- Based upon steel manufacturers data.

[Dimensions in Inches(mm)]



MAXIMA® COATING

Maxima is a premium tool steel coating that has been specially formulated for punch press tooling applications. Maxima is a multilayer Zirconium Titanium Nitride (ZrTiN) coating that is hard, wear resistant, and lubricious. It acts as a barrier between the punch and the sheet metal being punched and, because of its exceptional lubricity, greatly improves stripping.

Maxima is applied to the precision ground surface of Mate's premium tool steel punches. Maxima is an extremely hard, wear resistant, slippery material which reduces the friction that occurs during the stripping portion of the punching cycle, it is particularly good for abrasive tooling applications. Less friction means less heat build up, less galling, and longer tool life.



MATE SLUG FREE® DIES

Mate Slug Free® dies eliminate slug pulling. Slug pulling is a condition where the slug returns to the top of the sheet during the stripping portion of the punching cycle. The slug comes between the punch and the top of the sheet on the next cycle. This causes damage to the piece part and the tooling. Slug Free dies eliminate this problem.

The Slug Free die has been designed with an opening that has a constriction point below the surface so the slug cannot return once it passes this point. Once the slug is separated from the punch, it is free to fall away from the punching area. Slug pulling is eliminated.

- Eliminate slug pulling
- Reduce tool breakage
- Improve tool life
- Increase quality

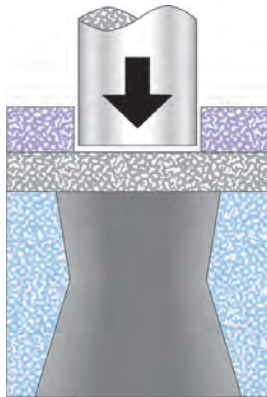

Material held securely by stripper before punch makes contact.

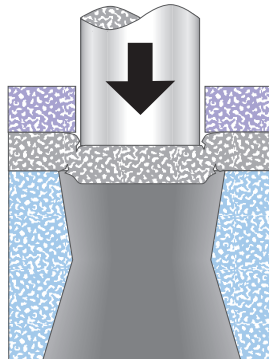

Punch penetrates the material. Slug fractures away from sheet.

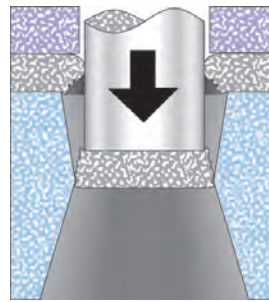

Pressure point constricts slug. Punch stroke bottoms out as slug squeezes past pressure point.

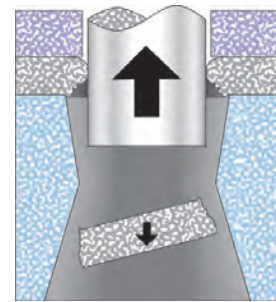

Punch retracts and slug is free to fall down and away through exit taper of the Slug Free® die.



[Dimensions in Inches(mm)]

SPECIAL APPLICATIONS

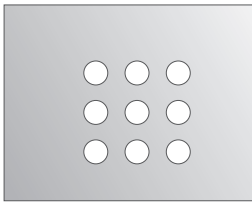

Cluster - Round

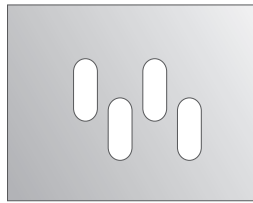

Cluster - Shape

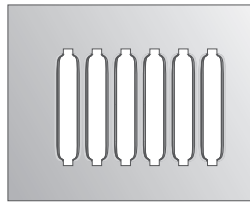

Card Guide



Centerpoint

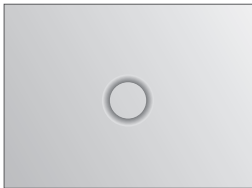

Countersink - Round



Countersink - Shape



Emboss - Beading



Emboss - Edgeform

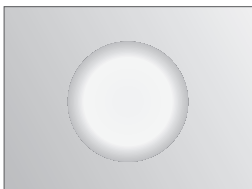

**Emboss - Formed
(Round and Shaped)**



Emboss - Cold Forged



Extrusion - Tapping



**Extrusion -
Flanged Hole**

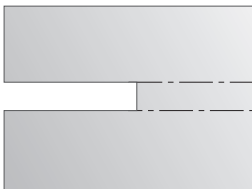

Guided Shearing



Hinge Tool

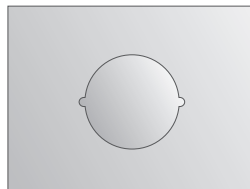

Knockout

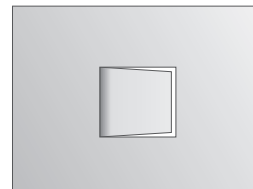

Lance and Form



Louver

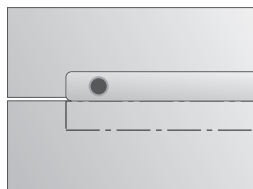

Scissortool™

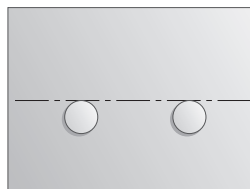

Shearbutton



Rollerball™



Sheetmarker™



Stamping - Alpha Numeric

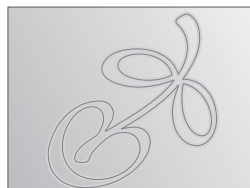

Stamping - V-line

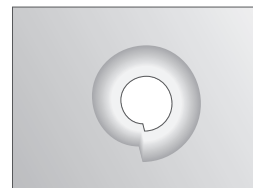

Threadform



[Dimensions in Inches(mm)]

HIGH PERFORMANCE FORMING TOOLS

Cluster

Use:

To produce multiple holes with minimal hits.

Typical Application:

Material thickness from 0.020(0.50) to 0.157(4.00).

Other constraints dependent upon station size, punch size and shape and press tonnage capacity.

Comments:

For greater hole uniformity and flatter sheets, spread the punches to avoid punching adjacent holes in the same hit.

Complete the desired pattern with the technique known as bridge hitting.

Do not re-punch through previously punched holes to complete a pattern, single hit tool may be necessary.

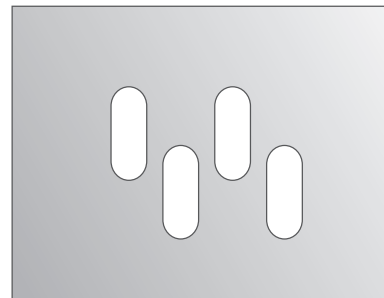
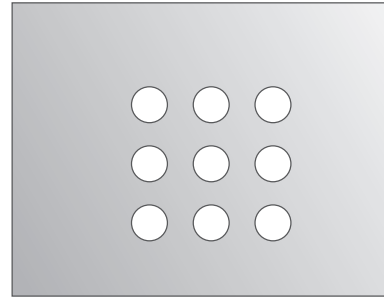

Card Guide

Use:

As a retainer for printed circuit boards.

Typical Application:

Material thickness from 0.040(1.00) to 0.078(2.00).

Maximum recommended top-to-top height 0.125(3.20).

Comments:

Length of the card guide is dependent upon station size and machine tonnage.

Also available as a continuous type form to increase productivity.



[Dimensions in Inches(mm)]

HIGH PERFORMANCE FORMING TOOLS

23

SPECIAL APPLICATIONS

Countersink

Use:

Allows screw head to reside flush or below the surface of the material.

Typical Application:

Material thickness from 0.048(1.22) to 0.250(6.35), dependent upon press tonnage capacity.

Comments:

The shoulder style (dedicated) is generally ordered for one material thickness and screw size.

The shoulder style coins the surrounding area producing a clean flat countersink with minimal burring.



Emboss - Beading

Use:

As a stiffener to add rigidity to sheet metal panels.

Typical Application:

Material thickness from 0.027(0.70) to 0.250(6.35), dependent upon press tonnage capacity.

Comments:

Increments between hits are determined by the cosmetic requirements for the finished part. Smaller increments result in better appearance.

To minimize the sheet distortion that results from forming metal, the form height should be as low as possible.



[Dimensions in Inches(mm)]



HIGH PERFORMANCE FORMING TOOLS

Emboss - Cold Forged

Use:

To produce a logo or design on a part.

Typical Application:

Material thickness from 0.018(0.46) to 0.118(3.00).

Best results in material thickness from 0.040(1.00) to 0.078(2.00).

Maximum size dependent on the tooling style, station size and press tonnage capacity.

Comments:

An exact drawing, CAD file or sample of logo is required in order to produce this type of assembly.



Emboss - Formed

Use:

Provides a recess or a protrusion.

Typical Application:

Material thickness from 0.027(0.70) to 0.250(6.35), dependent upon press tonnage capacity.

Comments:

Best results are attained when the side wall angle is 45° or less.

Optimum form height is 3 times the material thickness or less.



[Dimensions in Inches(mm)]

HIGH PERFORMANCE FORMING TOOLS

25

SPECIAL APPLICATIONS

Extrusion - Tapping

Use:

Threading for screws and increased bearing area for tubes, etc.

Typical Application:

Material thickness from 0.031(0.80) to 0.106(2.70).

Overall Height—2x to 2.5x material thickness.

Diameter—0.374(9.50) (M-10).

Comments:

Buy additional inverted dies to accommodate alternate material thicknesses.

Maximum diameter can be increased by using an alternative design.



Hinge

Use:

To create hinge knuckles as integral elements on sheet metal components.

Typical Application:

The range of this application is dependent on a combination of the material thickness, pin diameter, and feed gap of the press.

Comments:

An integral hinge knuckle on a component eliminates the costly process of purchasing and assembling separate hinges.

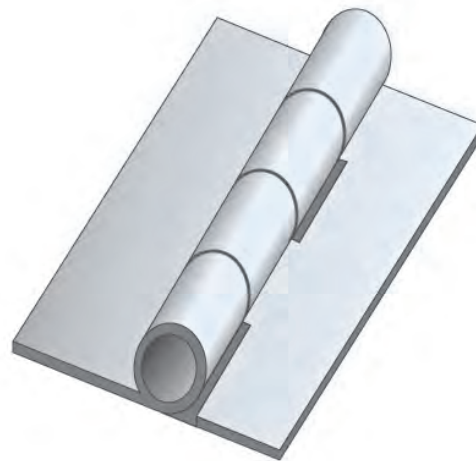

[Dimensions in Inches(mm)]



HIGH PERFORMANCE FORMING TOOLS

Knockout

Use:

Allows optional pathway for electrical cable.

Typical Application:

Material thickness from 0.024(0.60) to 0.118(3.00).
Maximum size dependent upon material type, thickness, and press tonnage capacity.

Comments:

The tool can be used with other material thickness within a range of + or - 0.016(0.40) from design thickness.

Maintain minimum of 0.236(6.00) difference between diameters used for knockout.



Louver

Use:

To provide air flow or ventilation.

Typical Application:

Material thickness from 0.028(0.70) to 0.106(2.70).
Maximum recommended top-to-top height is 0.255(6.50).

Comments:

One tool cuts the sheet and produces the form in the same operation.
The tool is designed for a specific material thickness.

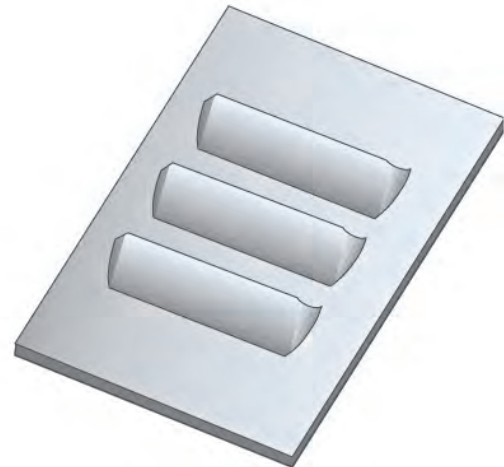

[Dimensions in Inches(mm)]

HIGH PERFORMANCE FORMING TOOLS

27

SPECIAL APPLICATIONS

Lance and Form

Use:

For air flow, decoration, card guides, location markers, shear tabs, wire harnesses or clip attachments.

Typical Application:

Material thickness from 0.020(0.50) thick to 0.118(3.00).
Maximum recommended top-to-top height is 0.250(6.40).
Other limitations include material type, thickness, station size and press tonnage capacity.

Comments:

The inclusion of a 5° draft angle is recommended to assure reliable operation.



Stamping—Alpha Numeric

Use:

To provide indelible marking of alpha-numeric characters on the top or bottom of the sheet. Example: part numbers.

Typical Application:

Material thickness from 0.032(0.80) up to machine capacity.
Characters available in 4 popular sizes. See table.

Comments:

Each individual character can be changed easily.

INSERT SIZES AVAILABLE

<u>Fractional Inch</u>	<u>Decimal Inch</u>	<u>Metric</u>
3/32	0.094	2.40
1/8	0.125	3.12
3/16	0.188	4.50
1/4	0.250	6.35

[Dimensions in Inches(mm)]



HIGH PERFORMANCE FORMING TOOLS

Stamping—V-Line Inscription

Use:

To produce logos, messages or symbols.

Typical Application:

Material thickness from 0.032(0.80) up to machine capacity.
Maximum size is dependent on station size and size of symbols and characters and press tonnage capacity.

Comments:

V-Line Stamping—renders the image with a thin, sharp line stamped into the surface.

An exact drawing, CAD file, or sample of logo is required in order to produce this type of assembly.



Threadform

Use:

To provide a form to accept a sheet metal screw (button head).

Typical Application:

Material thickness from 0.020(0.50) to 0.048(1.20).
Size is dependent upon screw size selected.
Thicker material requires a countersink operation or thinning prior to threadforming.

Comments:

Tool can be designed to suit either cut thread or rolled thread. You will need to specify thread type when ordering.



[Dimensions in Inches(mm)]

HIGH PERFORMANCE FORMING TOOLS

29

SPECIAL APPLICATIONS

Mate Rollerball®

Use:

The Rollerball® is an exciting new tool designed by Mate Precision Tooling to take advantage of the extended programming capabilities of hydraulic and other punch presses capable of operating in the X and Y axis with the ram down. The Rollerball® gives you the benefit of making forms not possible with single hit forming tools.

Typical Application:

Maximum workable material thickness is 0.105(2.70) mild steel.

Comments:

The press must be capable of holding the ram down while the sheet is moved on the X or Y axis.



Mate Sheetmarker®

Use:

For markings or etchings on the surface of sheet metal. The tool uses a diamond pointed insert in a spring loaded holder to create the marking.

Typical Application:

The Sheetmarker® Tool can be used on all material types and thickness.

Comments:

A wide variety of results can be produced, ranging from very light etching to fairly deep grooves in the sheet.

Variations are achieved with a combination of three spring pressures and insert point angles.



[Dimensions in Inches(mm)]



HIGH PERFORMANCE FORMING TOOLS

Mate SnapLock™

Use:

For joining materials, thus eliminating secondary operations such as spot welding, riveting, or fastening with threaded hardware.

Typical Application:

Material thickness from 0.020(0.50) up to 0.118(3.00).
Other limitations include material type, station size, and press tonnage capacity.

Comments:

Suitable for joining materials of dissimilar type and/or thickness.
Positive locking and locating feature for fast and accurate assembly.



Mate HexLock™

Use:

To provide a reliable and secure method of retaining common threaded fasteners in sheet metal.

Typical Application:

Material thickness from 0.020(0.50) up to 0.118(3.00).
Other limitations include material type, station size, and press tonnage capacity.

Comments:

Suitable for hexagon nuts and hexagon headed bolts that conform to DIN933 or DIN934

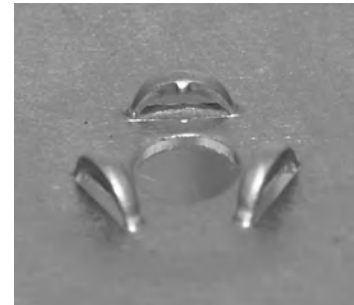

[Dimensions in Inches(mm)]

HIGH PERFORMANCE FORMING TOOLS

31

SPECIAL APPLICATIONS

Mate EasySnap™

Use:

Scrapless retention system to allow fabricator to snap punched parts out of sheet metal.

Typical Application:

Material thickness from 0.020(0.50) up to 0.078(2.00) for mild steel and aluminium, and 0.020(0.50) up to 0.059(1.50) for stainless steel.

Comments:

Reduces the need for slitting and micro joints for part retention. Material type and thickness must be specified at time of order.

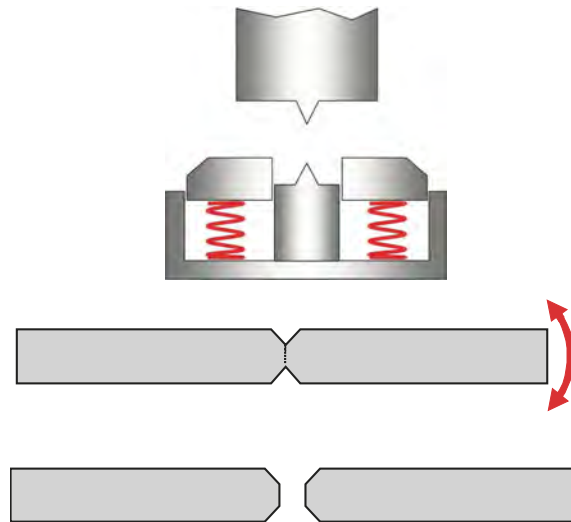

Mate 19" Racking Cluster

Use:

For high speed punching of the mounting hole pattern commonly found in electronic and telecommunications cabinets. The hole spacing conforms to DIN41494, IEC 297 and BS 5954.

Typical Application:

Material thickness from 0.020(0.50) up to 0.157(4.00)

Comments:

Special shape "U" pitch marker on the central punch point allows the end user to count pitches, not holes!

Solid (non-insert) style cluster tools and insert style cluster assembly options available.

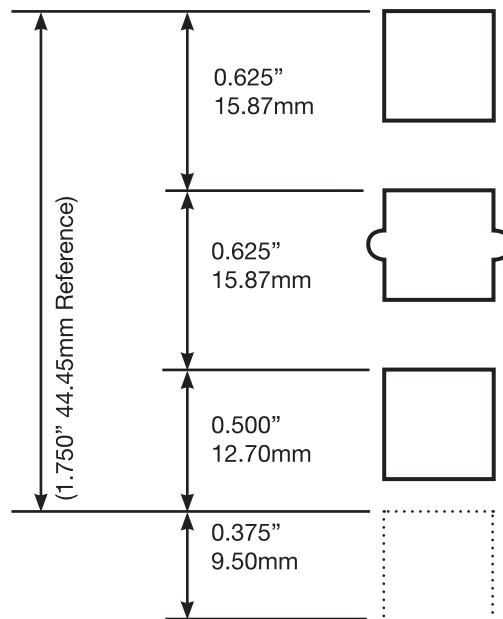

[Dimensions in Inches(mm)]

MATE SPECIAL SHAPES

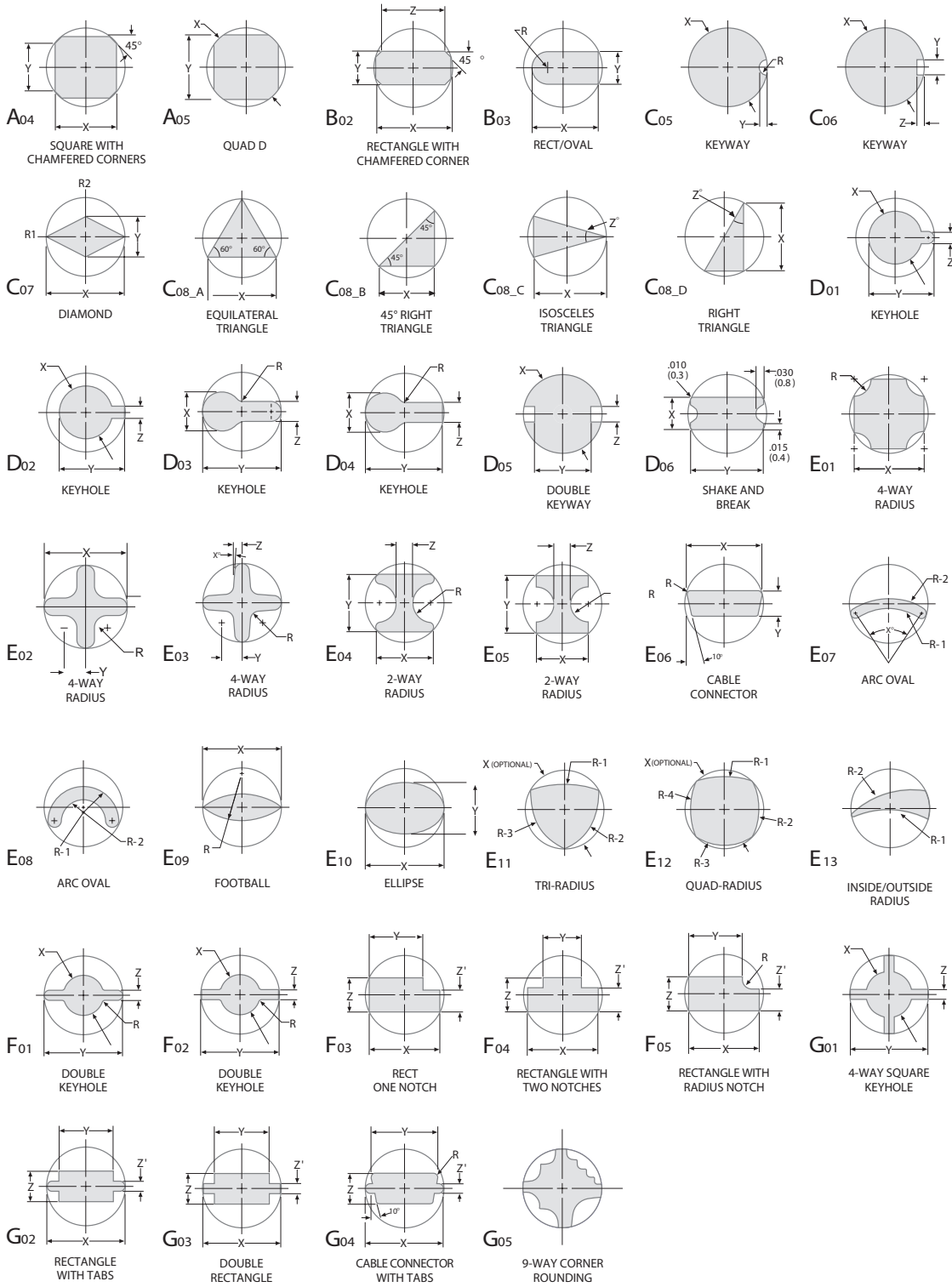

[Dimensions in Inches(mm)]

MATE SPECIAL SHAPES

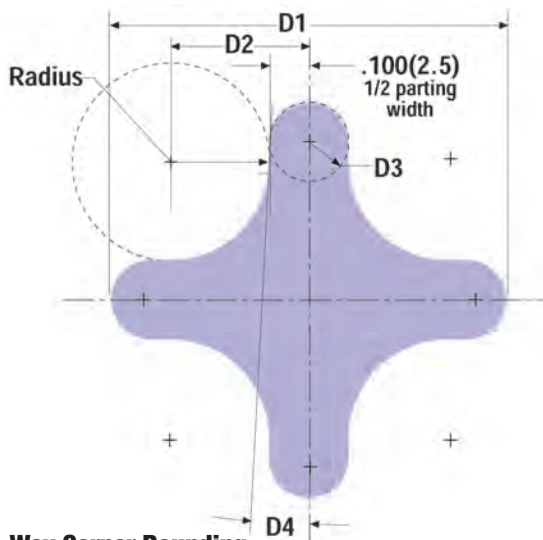

4-Way Corner Rounding

The 4-way corner rounding tool can round all four corners of a piece part without rotating the tooling—use with standard parting tools for piece part separation.

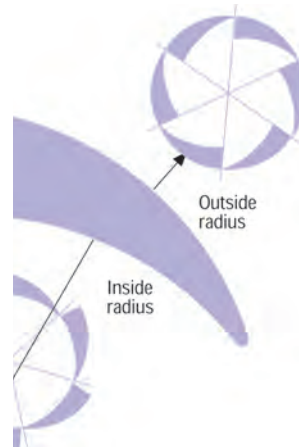

Inside/Outside Radius

This tool's large radii results in blanks with smoother edges produced in fewer hits than with an ordinary radius punch. This tool can be programmed to punch holes with slugs or parts retained in the sheet, yet can be separated easily off the press.

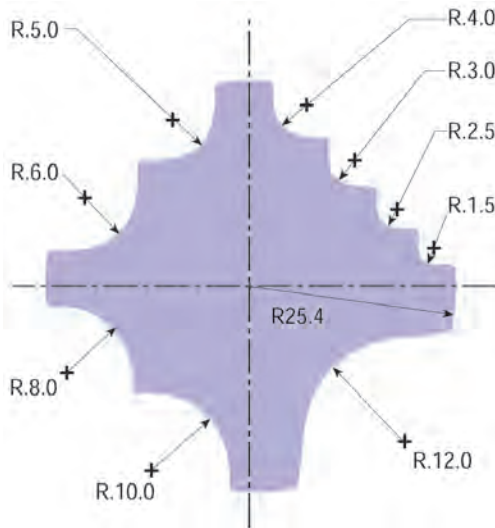

9-Way Corner Rounding

A single 9-way corner rounding tool provides nine popular radii in one tool. Auto-indexing selects and rotates the desired radius to round off all corners of a piece part. Alternate radii can be specified in inch or metric sizes.

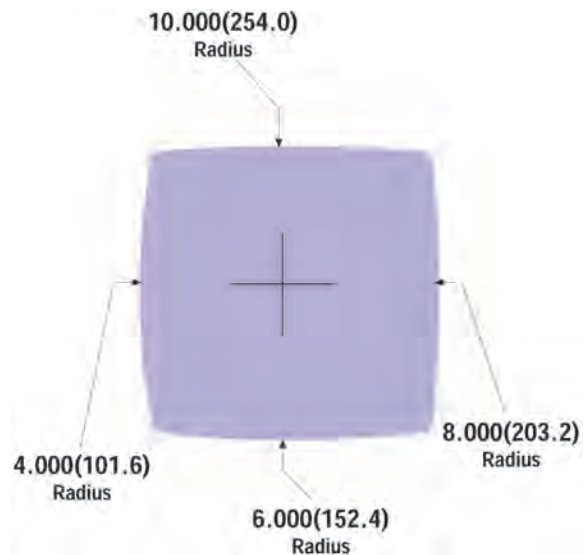

Quad Radius

The quad radius tool nibbles large holes with smoother edges and fewer hits than using a round nibbling punch. Smooth round holes are not limited to station range. Alternate radii can be specified in inch or metric sizes.

[Dimensions in Inches(mm)]



TOTAL DIE CLEARANCE AND HOLE QUALITY

Die clearance is equal to the space between the punch and die when the punch enters the die opening. It is always expressed as the TOTAL Clearance or TC. Using the correct die clearance increases tool life and improves piece part quality. The chart is based on experiences from our customers who achieve superior piece part quality and the longest possible tool life. Use the chart to determine the optimum clearance (percentage of material thickness) for piercing and blanking operations.

Blanking Tools are used to punch out a small part down the slug chute.

Material Type (Typical Shear Strength)	Material Thickness (T)	PIERCING	BLANKING
		Total Die Clearance (% of T)	Total Die Clearance (% of T)
Aluminum 25,000 psi (0.172 kN/mm ²)	Less than 0.098(2.50)	15%	15%
	0.098(2.50) through 0.197(5.00)	20%	15%
	Greater than 0.197(5.00)	25%	20%
Mild Steel 50,000 psi (0.344 kN/mm ²)	Less than 0.118(3.00)	20%	15%
	0.118(3.00) through 0.237(6.00)	25%	20%
	Greater than 0.237(6.00)	30%	20%
Stainless Steel 75,000 psi (0.517 kN/mm ²)	Less than 0.059(1.50)	20%	15%
	0.059(1.50) through 0.110(2.80)	25%	20%
	0.110(2.80) through 0.157(4.00)	30%	20%
	Greater than 0.157(4.00)	35%	25%

WHAT IS DIE CLEARANCE?

Die clearance is equal to the space between punch and die when the punch enters the die opening.

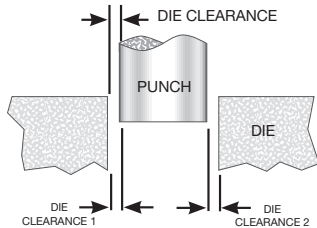

Total Die Clearance = Die Clearance on both sides of punch
 Total Die Clearance = Die Clearance 1 + Die Clearance 2
 Regardless of sheet thickness, the recommended penetration of the punch into a Slug Free® die is 0.118(3.00).

ANATOMY OF A PUNCHED HOLE

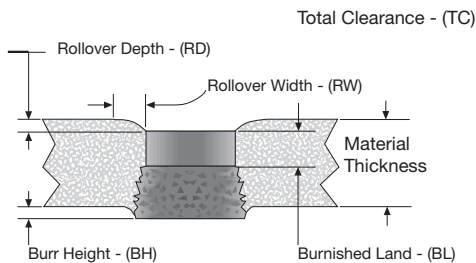

WHY USE PROPER DIE CLEARANCE?

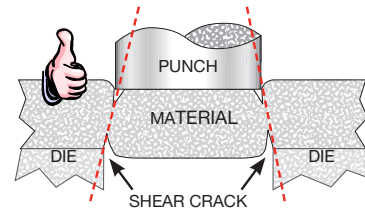

PROPER CLEARANCE -
 shear cracks join, balancing punching force, piece part quality, and tool life.

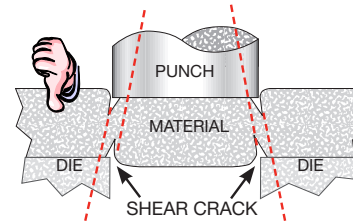

CLEARANCE TOO SMALL -
 secondary shear cracks are created, raising punching force, and shortening tool life.



[Dimensions in Inches(mm)]

CALCULATING PUNCHING FORCE

Tonnage Formula: Tonnage = Punch Perimeter x Material Thickness x Material Tonnage Value x Material Multiplier

EXAMPLE OF TONNAGE CALCULATION

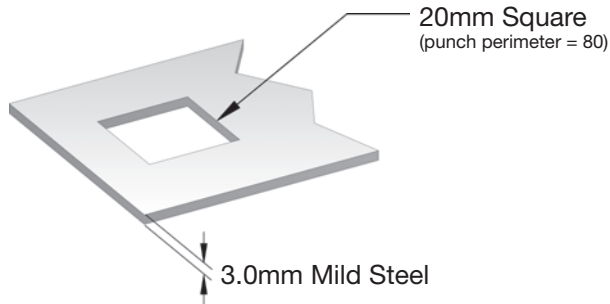

Metric Example:
Metric Tonnage for a 20mm square in 3.0mm Mild Steel
Tonnage = $80 \times 3.0 \times 0.0352 \times 1.0 = 8.45$ Metric Tons

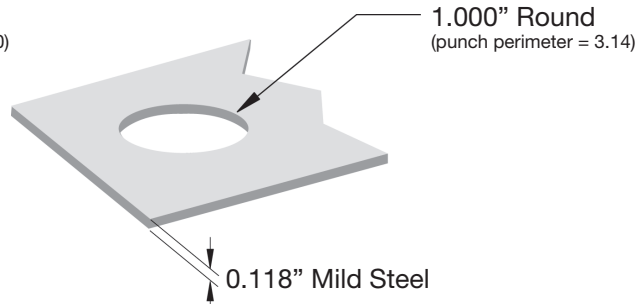

Inch Example:
Imperial Tonnage for a 1.000 inch round in 0.118 inch Mild Steel
Tonnage = $3.14 \times 0.118 \times 25 \times 1.0 = 9.27$ Imperial Tons

MATERIAL THICKNESS

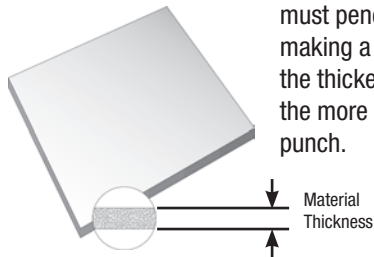

Material thickness is the width of the workpiece or sheet that the punch must penetrate in making a hole. Generally the thicker the material the more difficult it is to punch.

MATERIAL TONNAGE VALUE

INCH (IMPERIAL TONS/IN²)
25

METRIC (METRIC TONNES/MM²)
0.0352

MATERIAL MULTIPLIER

MATERIAL TYPE	MATERIAL MULTIPLIER
Aluminum (soft sheet)	0.30
Aluminum (1/2 hard)	0.40
Aluminum (full hard)	0.50
Copper (rolled)	0.60
Brass (soft sheet)	0.60
Brass (1/2 hard)	0.70
Mild Steel	1.00
Stainless Steel	1.60

PUNCHING FORCE CHANGES AS TOOLS DULL

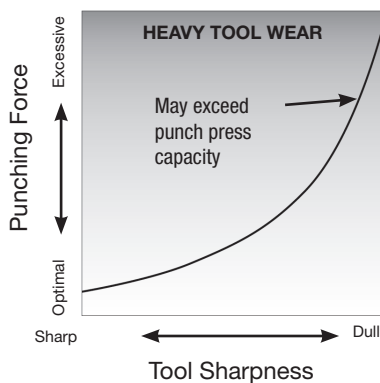

[Dimensions in Inches(mm)]



ANGLE SETTING DETAILS

DIE VIEW

SPECIFY THE DESIRED ANGLE, COUNTERCLOCKWISE FROM 0°, WHEN ORDERING CUSTOM DESIGNS

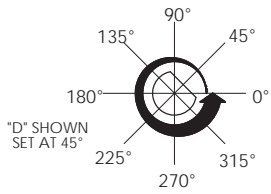
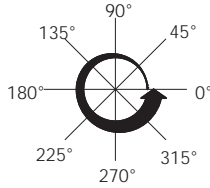

LEGEND

- = PUNCH
- = STRIPPER
- = DIE

SYMBOL OMITTED WHEN ORIENTATION IS NOT REQUIRED

PRIMARY KEY, PIN, OR SLOT ORIENTATION	
MTG 3 STATION (1.250")	MTG 8 STATION (0.500")
+	+

PRIMARY KEY, PIN, FLAT, HOLE, LUG OR SLOT ORIENTATION						
1/2" SNAP APART	5/8" DROP IN	1-1/4" FULL BODY	2" STRIPPIT	3-1/2" STRIPPIT	3-1/2" FULL BODY	3-1/2" INCH SHANK
+	+	+	+	+	+	+
		*1-1/4" FULL BODY KEVED STYLE (ROUNDS ONLY)				

ROUND	RECTANGLE	OVAL	SQUARE	SINGLE D	DOUBLE D	HEXAGON	OCTAGON
+	+	+	+	+	+	+	+

ADD-ONS FOR ROUNDS AND SHAPES

Narrow Width

Round point diameter is less than 0.061(1.55) - add 25% to punch, stripper and die.
 Round point diameter is less than 0.092(2.35) - add 10% to punch, stripper and die.
 Shape point width is less than 0.079(2.00) - add 25% to punch, stripper and die.

Non-Standard Angle Setting

Punches - add 25% to price for all stations.
 Stripper - add 25% to price for 1/2", 5/8" and 1-1/4" stations only.
 Dies - add 25% to price for all stations.

Maxima® Coating for Punches

Additional Cost

- 1/2" Snap Apart
- 5/8" Drop-In
- 1-1/4" Full Body
- 3-1/2" Xcel Inch Shank
- 1-1/4" Xcel™
- 3-1/2" Xcel™ Slitting Punch Insert
- MTG™ 8 Station Multi Tool
- MTG™ 3 Station Multi Tool



[Dimensions in Inches(mm)]

DIMENSIONAL AND PUNCH GRIND LIFE DATA

	1/2"	5/8"	1-1/4"	3-1/2"	3-1/2"	MTG™	MTG™
Tool Style	Snap-Apart	Drop-In	Full Body	Inch Shank	Slitting Insert	8 Station	3 Station
Maximum Diagonal	0.500(12.70)	0.625(14.87)	1.250(31.70)	3.500(88.90)	3.500(88.90)	0.500(12.70)	1.250(31.70)

Punch

Part Number Pre-Fix	PCSA	PDSX	PBSB	PLSD, F, H	PJSQ	PMSR	PMSQ
Head Diameter	N/A	N/A	N/A	N/A	N/A	0.750(19.10)	1.375(34.93)
Overall Length	5.480(131.19)	5.480(131.19)	5.480(131.19)	1.905(48.39)	2.040(51.82)	2.935(74.55)	3.250(82.55)
Shank Diameter	0.500(12.70)	0.625(14.87)	0.750(19.10)	1.000(25.40)	N/A	0.512(13.00)	1.250(31.70)
Body Diameter	N/A	N/A	1.250(31.70)	Variable	N/A	N/A	N/A
Thread	1/2-20	5/8-18	3/4-16	1/2-13	1/2-13	N/A	N/A
Shank Width	N/A	N/A	N/A	N/A	3.040(77.22)	N/A	N/A
Shank Thickness	N/A	N/A	N/A	N/A	0.7085(17.99)	N/A	N/A

Stripper

Part Number Pre-Fix	SCSA	SDSX	SBSB	SLSD	SJSD	SMSR	SMSQ
Thickness/Overall Length	0.600(15.24)	0.600(15.24)	3.032(77.01)	0.281(7.13)	0.281(7.13)	0.286(7.26)	0.250(6.35)
Outside Diameter	1.056(26.82)	1.056(26.82)	1.500(38.10)	3.995(101.47)	4.000(101.60)	1.056(26.82)	1.573(39.95)
Shoulder Diameter	N/A	N/A	1.975(50.17)	3.870(98.29)	3.870(98.29)	N/A	N/A

Part Number Pre-Fix	SESX
Thickness	0.286(7.26)
Outside Diameter	1.056(26.82)

Die

Part Number Pre-Fix	DASB	DASB	DASB	DCSD	DCSD	DESR	DESQ
Die Diameter	1.875(47.63)	1.875(47.63)	1.875(47.63)	4.937(125.40)	4.937(125.40)	1.000(25.40)	1.875(47.63)
Die Thickness	1.187(30.15)	1.187(30.15)	1.187(30.15)	0.850(21.59)	0.850(21.59)	0.596(15.14)	0.596(15.14)

Punch Grind Life*

Part Number Pre-Fix	PCSA	PDSX	PBSB	PLSD, F, H	PJSQ	PMSR	PMSQ
Punch Width	>0.126(3.20)	>0.126(3.20)	>0.126(3.20)	>0.197(5.00)	>0.197(5.00)	>0.094(2.39)	>0.156(3.96)
Punch Length	>0.157(3.99)	>0.157(3.99)	>0.157(3.99)			>0.094(2.39)	>0.187(4.75)
Straight Before Radius	0.722(18.34)	0.722(18.34)	0.722(18.34)	0.657(16.69)	0.906(23.01)	0.655(16.64)	0.750(19.05)
Stripper Land	0.141(3.58)	0.141(3.58)	0.258(6.55)	0.221(5.61)	0.221(5.61)	0.186(4.72)	0.240(6.10)
Material Thickness	0.048(1.22)	0.048(1.22)	0.048(1.22)	0.048(1.22)	0.048(1.22)	0.048(1.22)	0.048(1.22)
Die Penetration**	0.125(3.18)	0.125(3.18)	0.125(3.18)	0.125(3.18)	0.125(3.18)	0.125(3.18)	0.125(3.18)
Punch Grind Life*	0.408(10.36)	0.408(10.36)	0.291(7.39)	0.263(6.68)	0.433(11.00)	0.296(7.52)	0.337(8.56)

* Adjust the material thickness to determine the specific grind life for your application.
 ** Based on a 5.375(136.53) machine shut height.
 *** All dimensions are approximate and are to assist with product identification only.
 Contact Customer Services for specific information.

[Dimensions in Inches(mm)]





visit mate.com

MATE PRECISION TOOLING

WORLDWIDE HEADQUARTERS:

1295 Lund Boulevard, Anoka, Minnesota 55303 USA
Tel 763.421.0230 Fax 763.421.0285 mate.com

EUROPEAN HEADQUARTERS:

Gablonzer Str, 25, 61440 Oberursel, Germany
Tel +49.6171.8878.000 Fax +49.6171.8878.001 mate.de

© The Mate Logo is a registered trademark of Mate Precision Tooling Inc.
Xcel, SnapLock, HexLock, DuraSteel, EasySnap, and MTG are trademarks of Mate Precision Tooling Inc.
Slug Free, Rollerball, Sheetmarker, Scissors tool, and Maxima are registered trademarks of Mate Precision Tooling Inc.
Strippit is a registered trademark of LVD Strippit.

©2011 Mate Precision Tooling Inc.

LIT00560 Rev B